

Fencing - 1,15 / 2,35 m

Quick guide

deceuninck

Dimensions / Dimensions / Afmetingen / Abmessungen

EN

Height of screen: 1,15 or 1,85 m
Length/step of the screen: 2019 mm
Length of the planks: 2000 mm

FR

Hauteur du brise-vue: 1,15 ou 1,85 m
Entraxe du brise-vue: 2019 mm
Longueur des planches: 2000 mm

NL

Hoogte van het scherm: 1,15 of 1,85 m
Lengte/stap van het scherm: 2019 mm
Lengte van de planken: 2000 mm

DE

Sichtschutzhöhe: 1,15 oder 1,85 m
Sichtschutzlänge / -abschnitt: 2019 mm
Dielenlänge: 2000 mm

*On wall / Sur mur / Op een muur /
Auf Betonsockel*

*In concrete / Dans le béton /
In beton / Im Betonfundament*

*On existing non Twinson terrace or concrete /
Sur terrasse existante non Twinson ou béton /
Op bestaand niet Twinson terras of beton /
Auf bestehende Terrasse (keine Twinson -
Terrasse) oder Betonfundament*

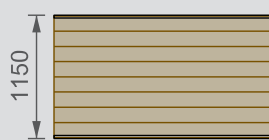

1,15 m: 8 x P 9555 or / ou / of / oder
8 x P 9340

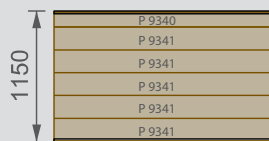

1,15 m: 1 x P 9340
5 x P 9341

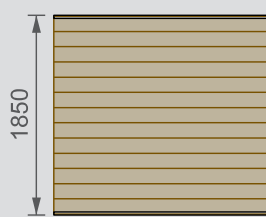

1,85 m: 13 x P 9555 or / ou / of / oder
13 x P 9340

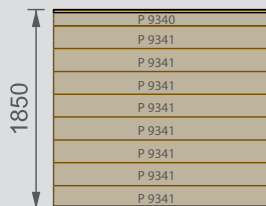

1,85 m: 1 x P 9340
8 x P 9341

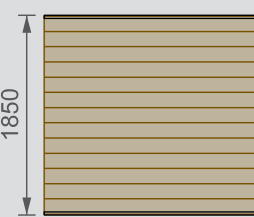

1,85 m: 13 x P 9555 or / ou / of / oder
13 x P 9340

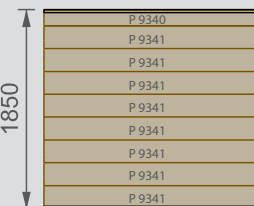

1,85 m: 1 x P 9340
8 x P 9341

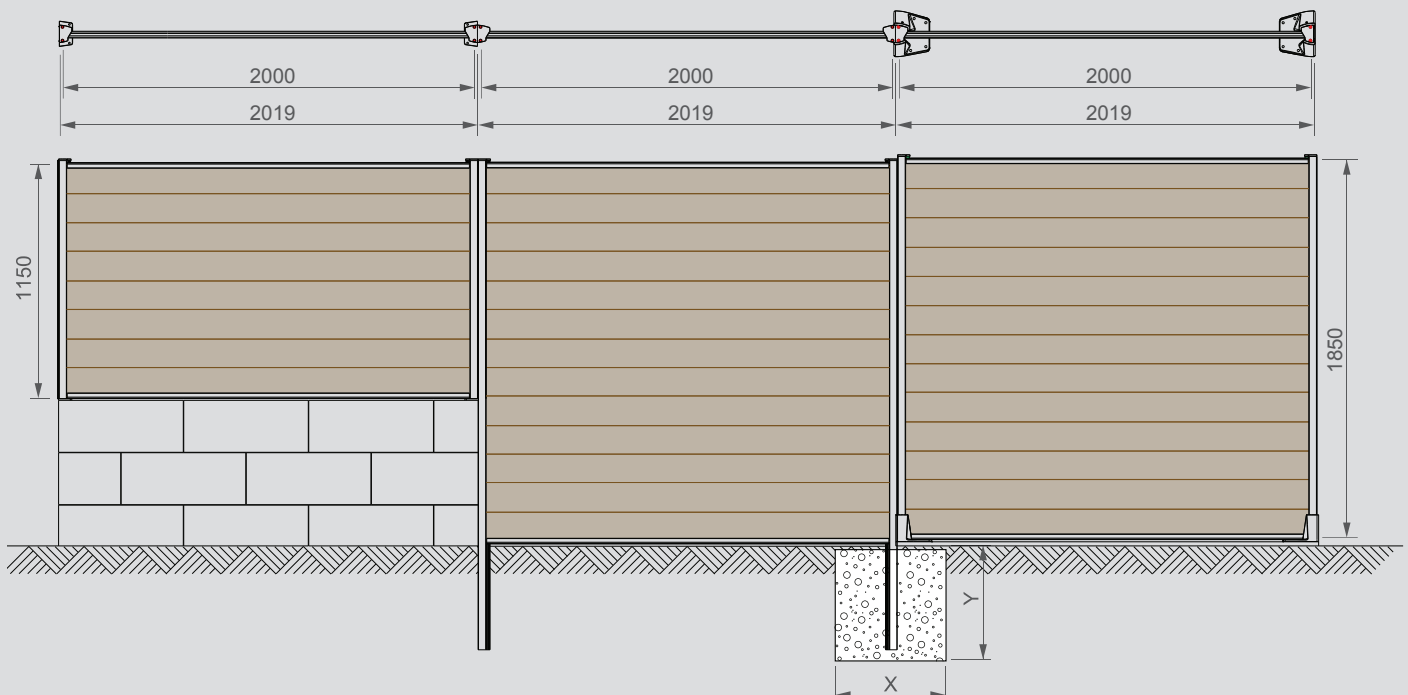

X: min. 500 mm → post / poteau / paal / Pfosten 2,35 m

Y: min. 500 mm → post / poteau / paal / Pfosten 2,35 m

General / Vue générale / Algemeen / Allgemeines

start post
poteau de départ
startpaal
Startpfosten

connection post
poteau intermédiaire
connectiepaal
Verbindungspfosten

corner post (90° - 179°)
poteau d'angle (90° - 179°)
hoekpaal (90° - 179°)
Eckpfosten (90° - 179°)

end post
poteau de fin
eindpaal
Endpfosten

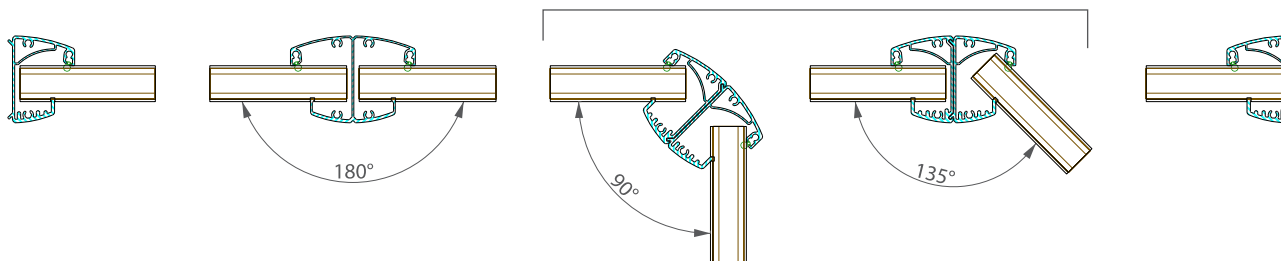

- EN** Cut the planks at exactly 2000 mm.
- FR** Couper les lames à exactement 2000 mm.
- NL** Zaag de planken exact op 2000 mm.
- DE** Schneiden Sie die Dielen auf genau 2000 mm zu.

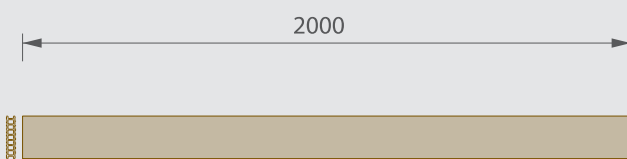

EN

- Tools: depending on installation method and application:
 - Shovel and spade
 - Post hole digger or soil drill
 - Spirit level
 - String line
 - Screwdriver
 - Drilling machine and HSS/ concrete drills
 - Jig saw
 - Laser
 - Concrete mixer

- No installation $\leq 0^\circ\text{C}$
- Installation forbidden on a Twinson terrace
- Install the planks in the same direction

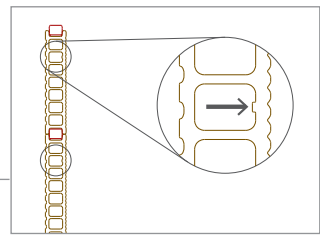

FR

- Outils: selon la méthode d'installation et l'utilisation:
 - Pelle et bêche
 - Creuser ou percer un trou dans le sol pour le poteau
 - Niveau à bulle
 - Fil à plomb
 - Tournevis
 - Scie sauteuse
 - Perceuse HSS / Foret béton
 - Laser
 - Bétonnière

- Aucune installation à une température $\leq 0^\circ\text{C}$
- Installation interdite sur une terrasse Twinson
- Installer les lames dans le même sens

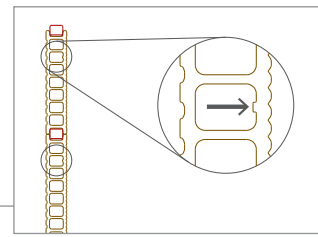

NL

- Werktuigen: afhankelijk van de installatiemethode en toepassing:
 - Schop en spade
 - Paalgraafmachine of grondboor
 - Waterpas
 - Metserskoord
 - Schroevendraaier
 - Boormachine met metaal/ betonboor
 - Decoupeerzaag
 - Laser
 - Betonmixer

- Geen installatie $\leq 0^\circ\text{C}$
- Installatie op een Twinson terras verboden
- Installeer de planken in dezelfde richting

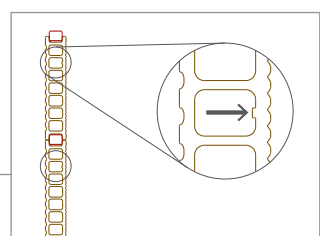

DE

- Werkzeuge: abhängig von der Montagevariante:
 - Schaufel und Spaten
 - Erdbohrer oder Bodenbohrer
 - Wasserwaage
 - Schnur
 - Schraubenzieher
 - Bohrmaschine und HSS / Betonbohrer
 - Stichsäge
 - Lasergerät
 - Betonmischmaschine

- Keine Montage $\leq 0^\circ\text{C}$
- Montage auf Twinson Terrasse verboten
- Montieren Sie die Dielen in der gleichen Richtung

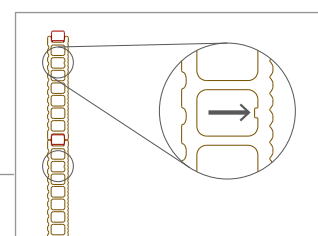





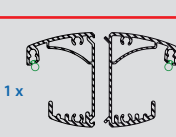









Overview kits / Vue d'ensemble du kit / Overzicht kits / Übersicht Kits

Kit P 9282



1x
Start - End / Cornerpost

- 1x 
- 21x  
- 2x  
- 1x  
- 2x  
- 1x  
- 4x  
- 6x  

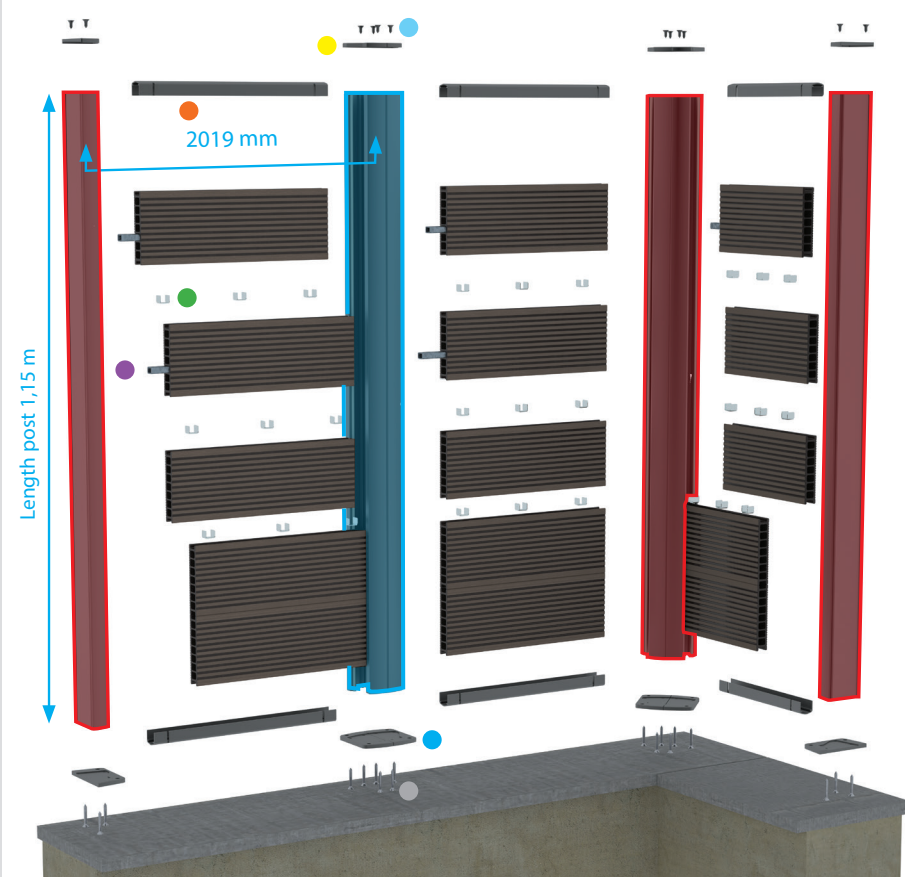







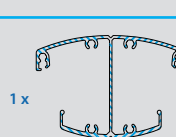







Length post 1,15 m

2019 mm

Kit P 9274









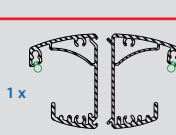



1x
Connection post

- 1x 
- 21x  
- 2x  
- 1x  
- 2x  
- 1x  
- 4x  
- 6x  

Kit P 9283



1x
Start - End / Cornerpost

- 1x 
- 36x  
- 2x  
- 1x  
- 3x  
- 4x  

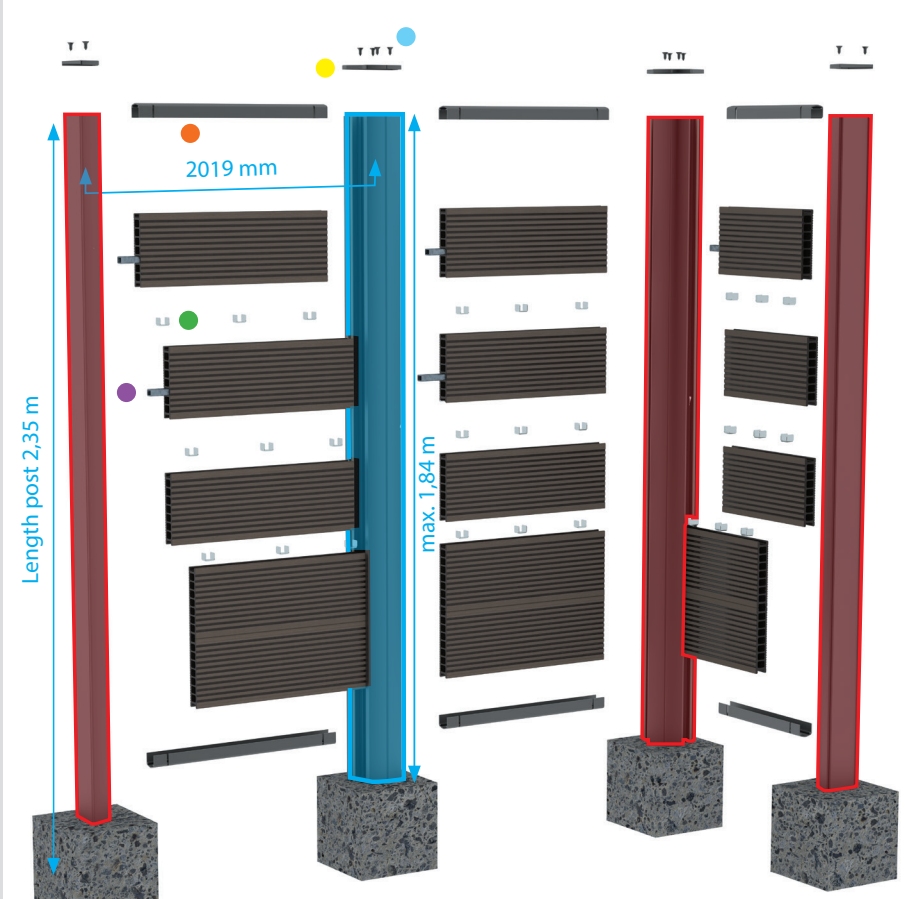

Length post 2,35 m







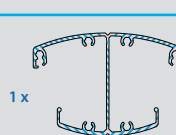



2019 mm

max. 1,84 m

Kit P 9275



1x
Connection post







- 1x 
- 36x  
- 2x  
- 1x  
- 3x  
- 4x  

Overview kits / Vue d'ensemble du kit / Overzicht kits / Übersicht Kits

Kit P 9283



1 x
Start - End / Cornerpost

- 1 x 
- 36 x 
- 2 x 
- 1 x 
- 3 x 
- 4 x 
- 6 x 

Kit P 9272
OPTIONAL

- 2 x 

Kit P 9273
OPTIONAL

- 1 x 

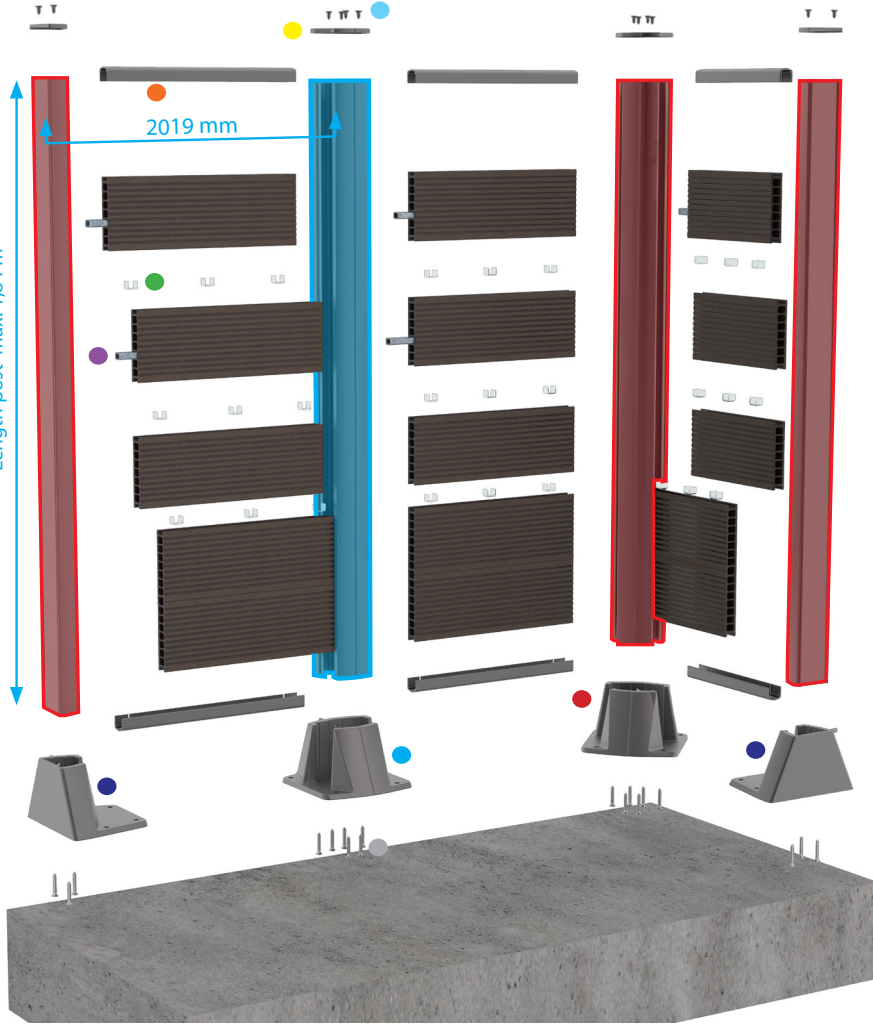





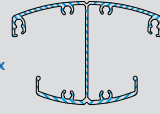

2019 mm

Length post max. 1,84 m

Kit P 9275







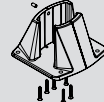

1 x
Connection post

- 1 x 
- 36 x 
- 2 x 
- 1 x 
- 3 x 
- 4 x 
- 6 x 

Kit P 9273
OPTIONAL

- 1 x 

Installation on wall → kits without planks / Installation sur mur → kit sans lames Installatie op een muur → kits zonder planken / Montage auf Betonsockel → Kits ohne Dielen				Total length of fencing / Longueur total du brise-vue Totale lengte tuinomheining / Gesamtlänge Sichtschutz					
Type of fencing / Type de brise-vue Type tuinomheining / Sichtschutzvariante	Ref	Kit with / Kit avec / Kit met / Kit mit		2,0 m	4,0 m	6,0 m	8,0 m	10,0 m	12,0 m
	P 9282 (1,15 m)	start - end / post start- / eindpaal	poteau de départ / de fin Start- / Endpfosten	1	1	1	1	1	1
	P 9274 (1,15 m)	connection post connectiepaal	poteau intermédiaire Verbindungspfosten	0	1	2	3	4	5
	P 9555	planks (linear meter) planken (lopemde meter)	planches (mètres linéaires) Dielen (Laufmeter)	16	32	48	64	80	96
	P 9282 (1,15 m)	start - end / post start- / eindpaal	poteau de départ / de fin Start- / Endpfosten	/	2	2	2	2	2
	P 9274 (1,15 m)	connection post connectiepaal	poteau intermédiaire Verbindungspfosten	/	0	1	2	3	4
	P 9555	planks (linear meter) planken (lopemde meter)	planches (mètres linéaires) Dielen (Laufmeter)	/	32	48	64	80	96
	P 9282 (1,15 m)	start - end / post start- / eindpaal	poteau de départ / de fin Start- / Endpfosten	/	/	3	3	3	3
	P 9274 (1,15 m)	connection post connectiepaal	poteau intermédiaire Verbindungspfosten	/	/	0	1	2	3
	P 9555	planks (linear meter) planken (lopemde meter)	planches (mètres linéaires) Dielen (Laufmeter)	/	/	48	64	80	96

Installation in concrete or on existing non Twinson terrace or concrete → kits without planks / Installation dans le béton ou sur terrasse existante non Twinson ou béton → kit sans lames / Installatie in beton of op bestaande niet Twinson terras of beton → kits zonder planken / Montage auf Betonfundament oder bestehende Terrasse (keine Twinson Terrasse) oder Beton → Kits ohne Dielen				Total length of fencing / Longueur total du brise-vue Totale lengte tuinomheining / Gesamtlänge Sichtschutz					
Type of fencing / Type de brise-vue Type tuinomheining / Sichtschutzvariante	Ref	Kit with / Kit avec / Kit met / Kit mit		2,0 m	4,0 m	6,0 m	8,0 m	10,0 m	12,0 m
	P 9283 (2,35 m)	start - end / post start- / eindpaal	poteau de départ / de fin Start- / Endpfosten	1	1	1	1	1	1
	P 9275 (2,35 m)	connection post connectiepaal	poteau intermédiaire Verbindungspfosten	0	1	2	3	4	5
	P 9555	planks (linear meter) planken (lopemde meter)	planches (mètres linéaires) Dielen (Laufmeter)	26	52	78	104	130	156
	P 9272 OPTIONAL	start - end / skirt start- / eindvoet	sabot de départ / de fin Befestigungsfuß Start-/ Endpfosten	1	1	1	1	1	1
	P 9273 OPTIONAL	connection skirt connectievoet	sabot intermédiaire Befestigungsfuß Verbindungspfosten	0	1	2	3	4	5
	P 9283 (2,35 m)	start - end / post start- / eindpaal	poteau de départ / de fin Start- / Endpfosten	/	2	2	2	2	2
	P 9275 (2,35 m)	connection post connectiepaal	poteau intermédiaire Verbindungspfosten	/	0	1	2	3	4
	P 9555	planks (linear meter) planken (lopemde meter)	planches (mètres linéaires) Dielen (Laufmeter)	/	52	78	104	130	156
	P 9272 OPTIONAL	start - end / skirt start- / eindvoet	sabot de départ / de fin Befestigungsfuß Start-/ Endpfosten	/	1	1	1	1	1
	P 9273 OPTIONAL	connection skirt connectievoet	sabot intermédiaire Befestigungsfuß Verbindungspfosten	/	1	2	3	4	5
	P 9283 (2,35 m)	start - end / post start- / eindpaal	poteau de départ / de fin Start- / Endpfosten	/	/	3	3	3	3
	P 9275 (2,35 m)	connection post connectiepaal	poteau intermédiaire Verbindungspfosten	/	/	0	1	2	3
	P 9555	planks (linear meter) planken (lopemde meter)	planches (mètres linéaires) Dielen (Laufmeter)	/	/	78	104	130	156
	P 9272 OPTIONAL	start - end / skirt start- / eindvoet	sabot de départ / de fin Befestigungsfuß Start-/ Endpfosten	/	/	1	1	1	1
	P 9273 OPTIONAL	connection skirt connectievoet	sabot intermédiaire Befestigungsfuß Verbindungspfosten	/	/	2	3	4	5



Installation on wall
 Installation sur mur
 Installatie op een muur
 Montage auf Betonsockel

start - end / post
 poteau de départ / de fin
 start - / eindpaal
 Start - / Endpfosten

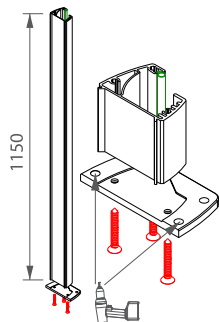

connection post (180°)
 poteau intermédiaire (180°)
 connectiepaal (180°)
 Verbindungspfosten (180°)

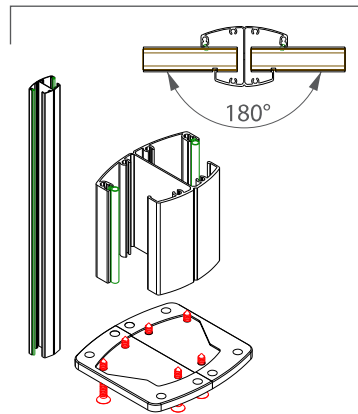

corner post (90° - 179°)
 poteau d'angle (90° - 179°)
 hoekpaal (90° - 179°)
 Eckpfosten (90° - 179°)

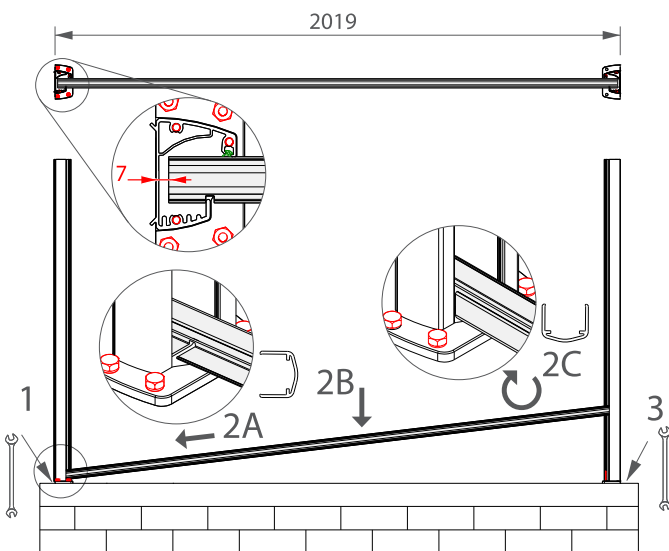
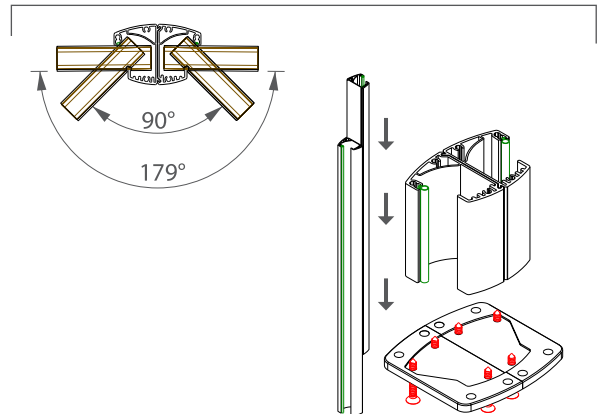

EN

Fixation depending on foundation.
 Please follow the manufacturer's instructions for all products.
IMPORTANT: keep on both sides a minimum dilatation space of 7 mm between the aluminium finishing profile, the plank and the post.

FR

Fixation selon fondation/support.
 Veuillez suivre les instructions du fabricant pour tous les produits.
IMPORTANT: espace de dilatation minimum de 7 mm entre le profilé de finition alu, la lame et le poteau.

NL

Vastzetting afhankelijk van de ondergrond.
 Gelieve voor alle producten de instructies van de fabrikant te volgen.
BELANGRIJK: een minimum uitzetvoeg van 7 mm voorzien tussen het aluminium afwerkingsprofiel, de plank en de paal.

DE

Befestigung abhängig vom Fundament.
 Bitte beachten Sie die Herstellerangaben für alle Produkte.
WICHTIG: die Dehnfuge zwischen dem Aluminiumabschlussprofil, der Diele und dem Pfosten muss mindestens 7 mm sein.

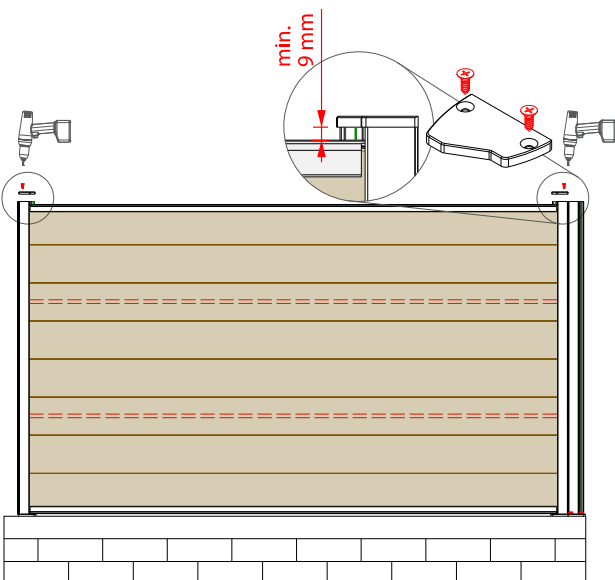
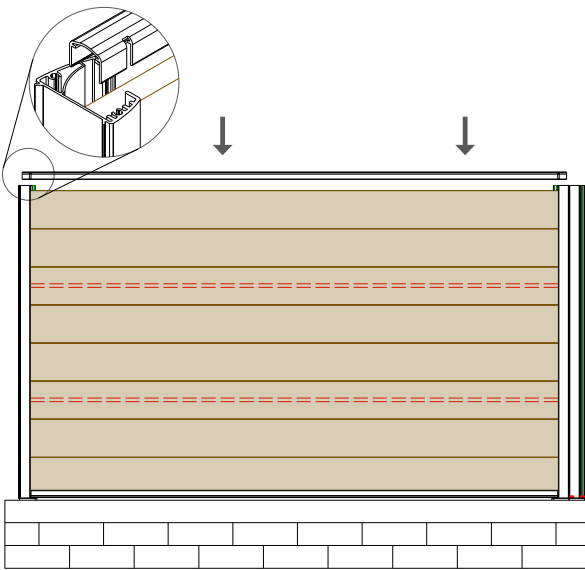
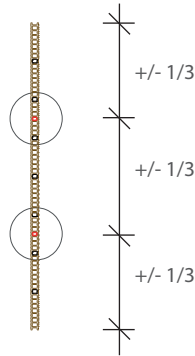
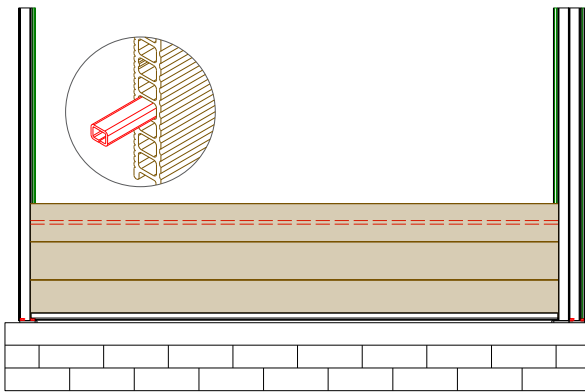
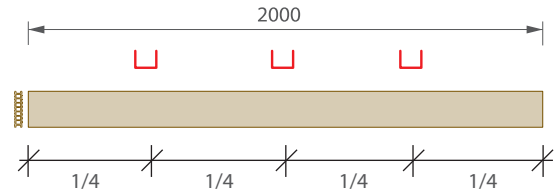
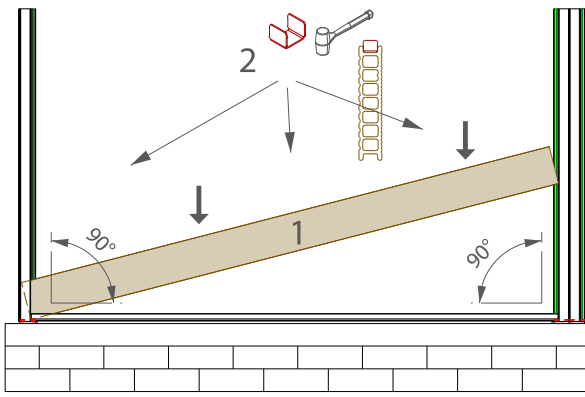

- EN** IMPORTANT: keep on both sides a minimum dilatation space of 9 mm between the top aluminium finishing profile and the endcap of the post.
- FR** IMPORTANT: espace de dilatation minimum de 9 mm entre le profilé de finition alu et le poteau.
- NL** BELANGRIJK: een minimum uitzetvoeg van 9 mm voorzien tussen het aluminium afwerkingsprofiel en de einddop van de paal.
- DE** WICHTIG: die Dehnfuge zwischen dem oberen Aluminiumabschlussprofil und der Pfostenabdeckung muss mindestens 9 mm sein.



Installation in concrete
 Installation dans le béton
 Installatie in beton
 Montage im Betonfundament

start - end / post
 poteau de départ / de fin
 start- / eindpaal
 Start- / Endpfosten

connection post (180°)
 poteau intermédiaire (180°)
 connectiepaal (180°)
 Verbindungspfosten (180°)

corner post (90° - 179°)
 poteau d'angle (90° - 179°)
 hoekpaal (90° - 179°)
 Eckpfosten (90° - 179°)

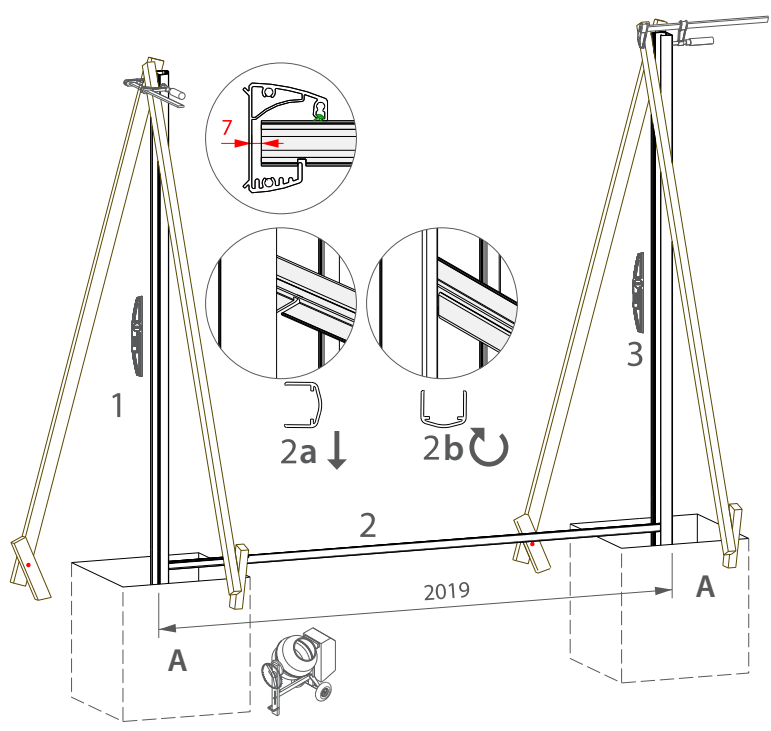
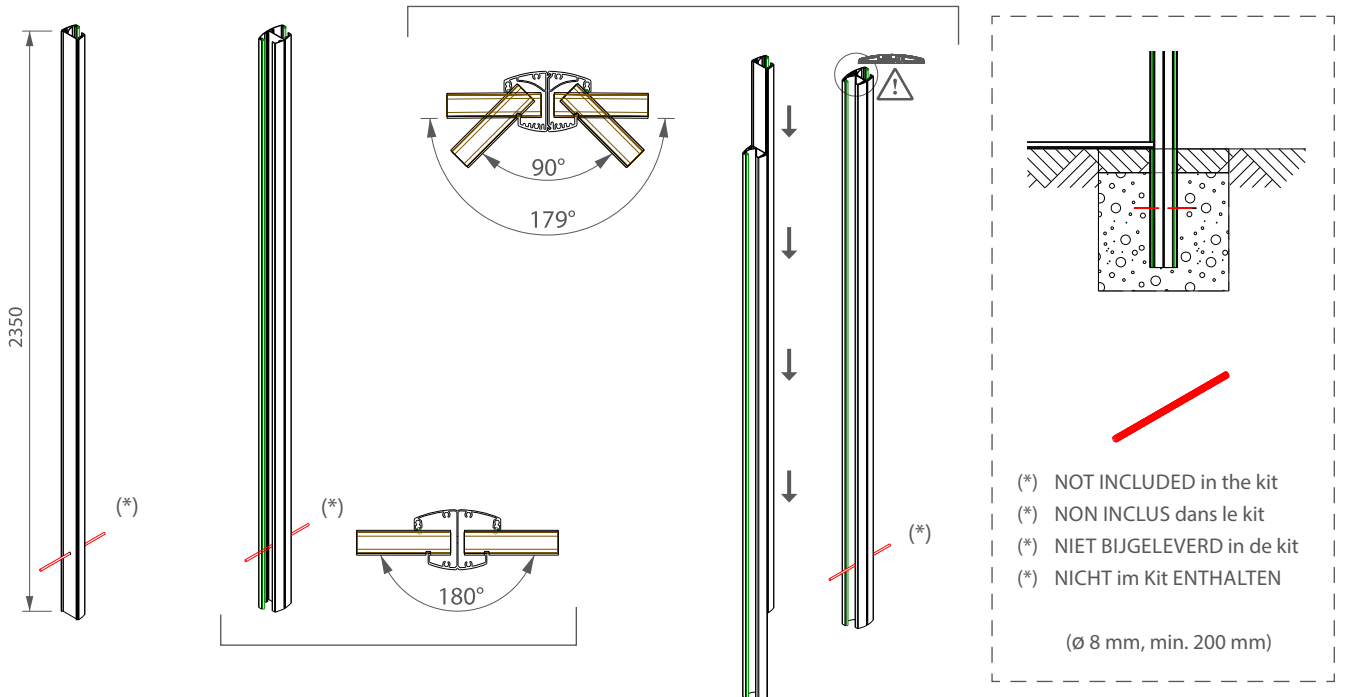

- EN** A = concrete (fine grind, sand, min. 300 kg/m³ cement)
 Block the lower U-profile (2) to avoid sagging.
IMPORTANT: keep a minimum dilatation space of 7 mm between the aluminium finishing profile, the plank and the post.
- FR** A = béton (mélange fin, sable, min. 300 kg/m³ ciment)
 Bloquer le profilé bas en U (2) pour éviter l'affaissement.
IMPORTANT: espace de dilatation minimum de 7 mm entre le profilé de finition alu, la lame et le poteau.
- NL** A = beton (fijn grind, zand, min. 300 kg/m³ cement)
 Blokkeer het onderste U-profiel (2) om het doorzakken te voorkomen.
BELANGRIJK: een minimum uitzegvoeg van 7 mm voorzien tussen het aluminium afwerkingsprofiel, de plank en de paal.
- DE** A = Beton (Kies, Sand, mind. 300 kg/m³ Zement)
 Blockieren Sie das untere U-Profil (2) um eine Durchbiegung zu vermeiden.
WICHTIG: die Dehnfuge zwischen dem Aluminiumabschlussprofil und dem Pfosten muss mindestens 7 mm sein.

- EN** Post 2,35 m
B = soil (100 mm).
C = concrete (min. 500 mm).
- FR** Poteau 2,35 m
B = sol (100 mm).
C = béton (min. 500 mm).
- NL** Paal 2,35 m
B = aarde of gras (100 mm).
C = beton (min. 500 mm).
- DE** Pfosten 2,35 m
B = Erdboden (100 mm).
C = Beton (min. 500 mm).

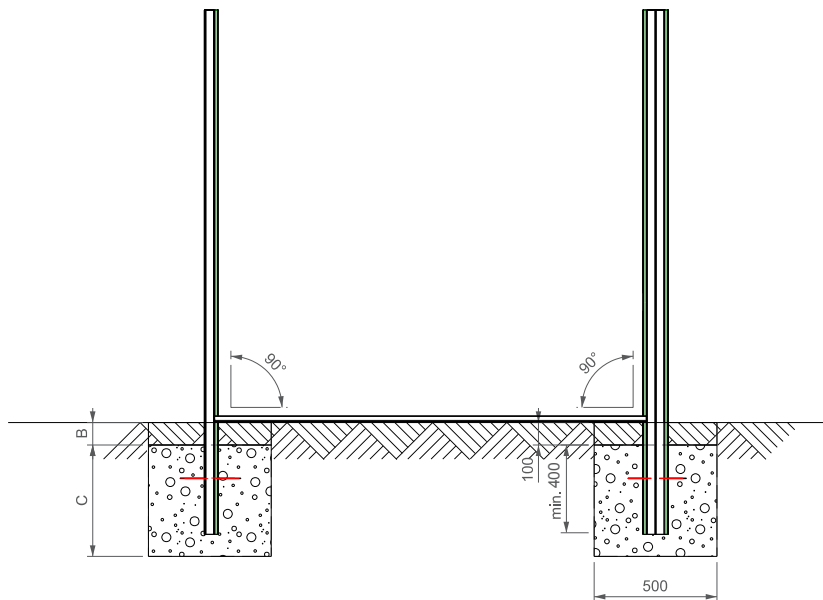

! Please pay attention to the installation direction of the planks.
Attention au sens d'installation des lames.
Gelieve de installatierichting van de planken te respecteren.
Bitte beachten Sie die Montagerichtung der Dielen.

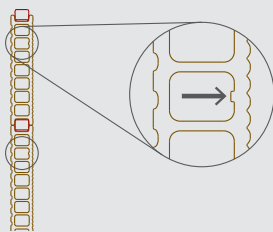

EN **IMPORTANT:** keep on both sides a minimum dilatation space of 9 mm between the top aluminium finishing profile and the endcap of the post.

FR **IMPORTANT:** espace de dilatation minimum de 9 mm entre le profilé de finition alu et le poteau.

NL **BELANGRIJK:** een minimum uitzetvoeg van 9 mm voorzien tussen het aluminium afwerkingsprofiel en de einddop van de paal.

DE **WICHTIG:** die Dehnfuge zwischen dem oberen Aluminiumabschlussprofil und der Pfostenabdeckung muss mindestens 9 mm sein.

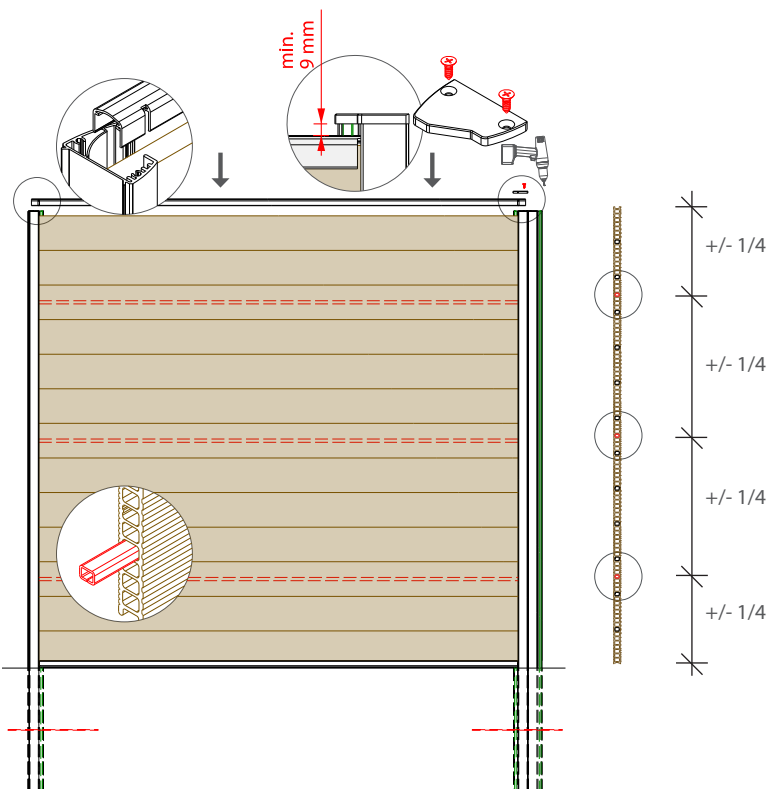
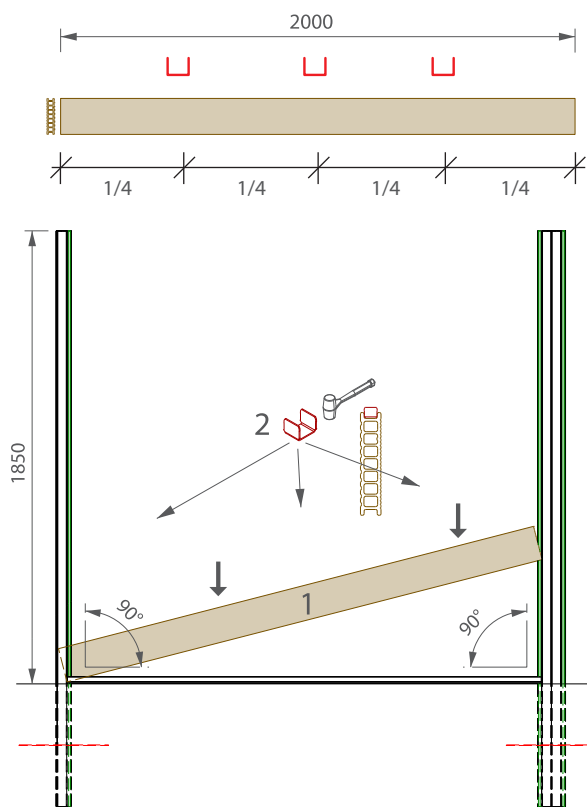



Installation on an existing non Twinson terrace or concrete
 Installation sur une terrasse existante non Twinson ou béton
 Installatie op een bestaande niet Twinson terras of beton
 Montage auf bestehende Terrasse (keine Twinson - Terrasse)
 oder Betonfundament

start - end / post
 poteau de départ / de fin
 start- / eindpaal
 Start- / Endpfosten

connection post (180°)
 poteau intermédiaire (180°)
 connectiepaal (180°)
 Verbindungspfosten (180°)

corner post (90° - 179°)
 poteau d'angle (90° - 179°)
 hoekpaal (90° - 179°)
 Eckpfosten (90° - 179°)

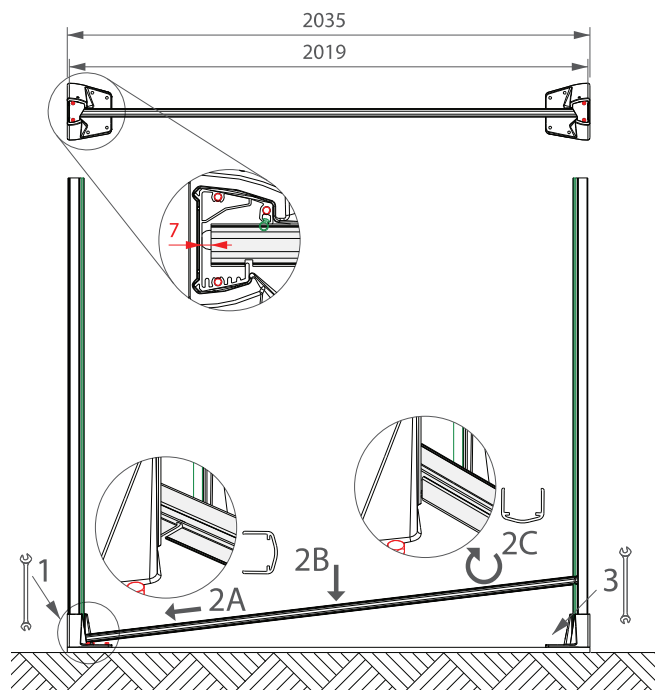
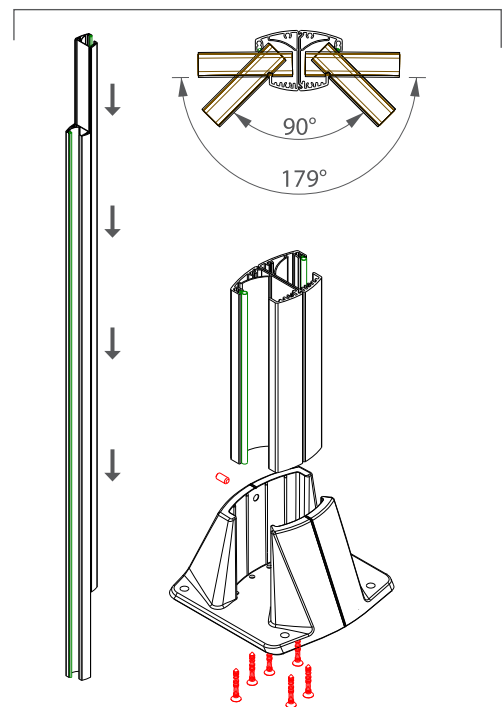
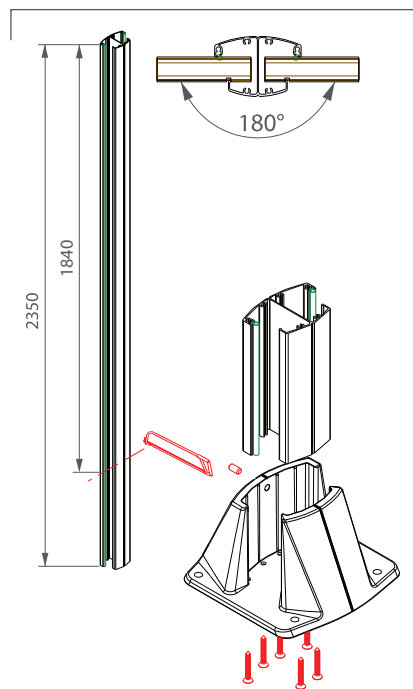
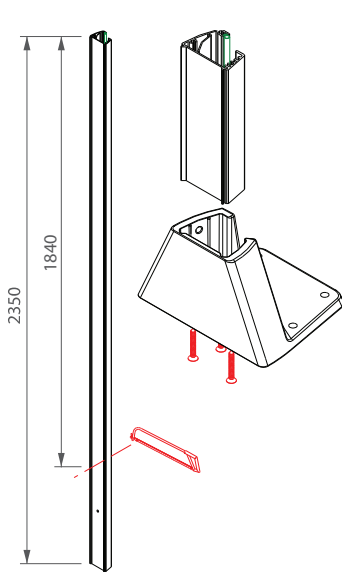

- EN** Fixation depending on foundation.
 Please follow the manufacturer's instructions for all products.
IMPORTANT: keep on both sides a minimum dilatation space of 7 mm between the aluminium finishing profile, the plank and the post.
- FR** Fixation selon fondation/support.
 Veuillez suivre les instructions du fabricant pour tous les produits.
IMPORTANT: espace de dilatation minimum de 7 mm entre le profilé de finition alu, la lame et le poteau.
- NL** Vastzetting afhankelijk van de ondergrond.
 Gelieve voor alle producten de instructies van de fabrikant te volgen.
BELANGRIJK: een minimum uitzetvoeg van 7 mm voorzien tussen het aluminium afwerkingsprofiel, de plank en de paal.
- DE** Befestigung abhängig vom Fundament.
 Bitte beachten Sie die Herstellerangaben für alle Produkte.
WICHTIG: die Dehnfuge zwischen dem Aluminiumabschlussprofil, der Diele und dem Pfosten muss mindestens 7 mm sein.

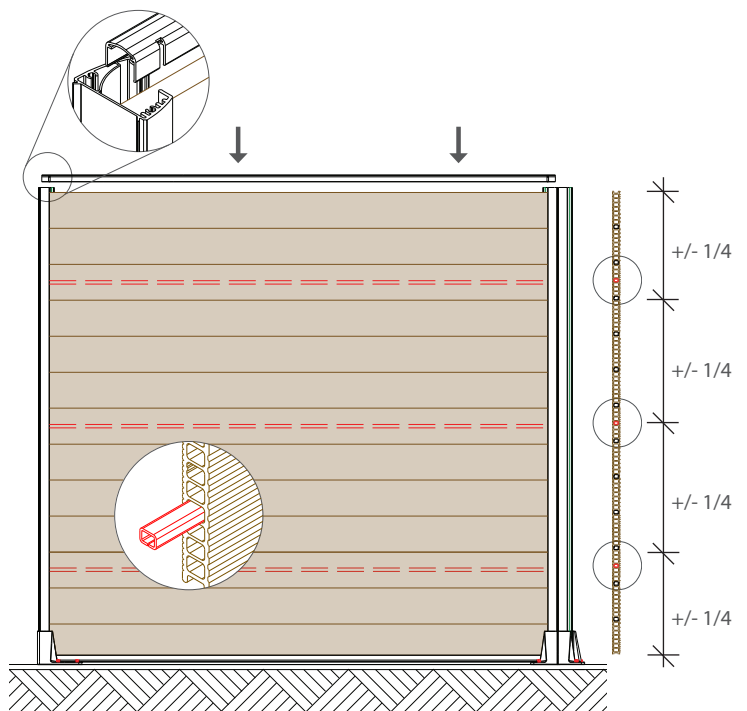
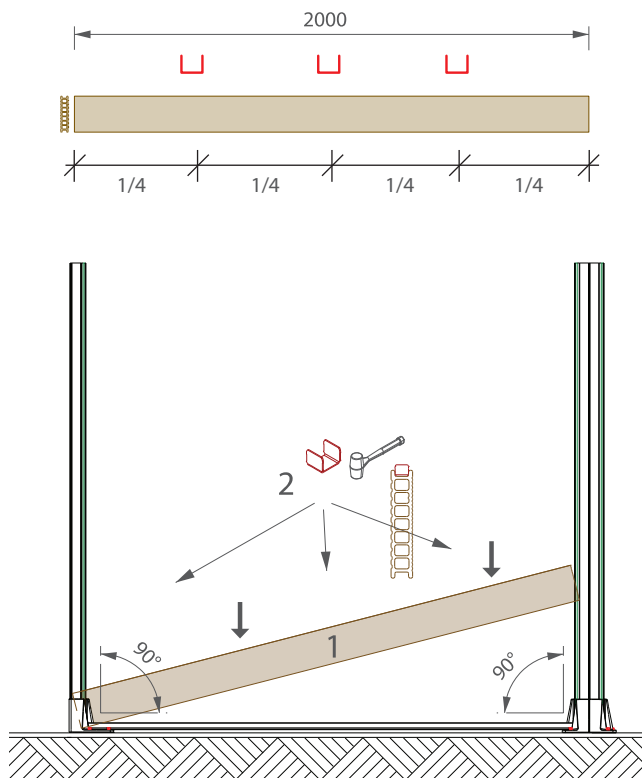

! Please pay attention to the installation direction of the planks.
 Attention au sens d'installation des lames.
 Gelieve de installatierichting van de planken te respecteren.
 Bitte beachten Sie die Montagerichtung der Dielen.

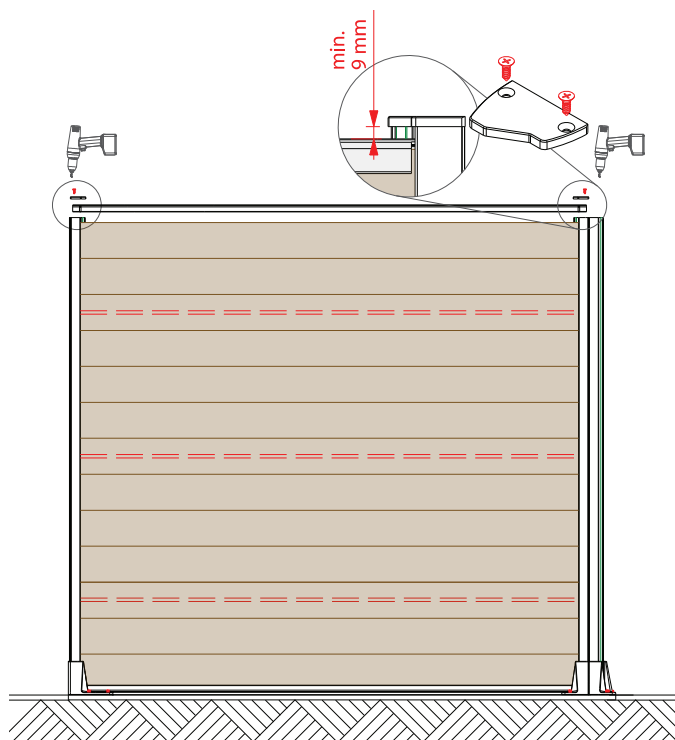
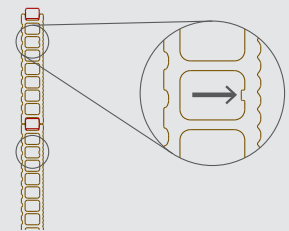

- EN **IMPORTANT** : keep on both sides a minimum dilatation space of 9 mm between the top aluminium finishing profile and the endcap of the post.
- FR **IMPORTANT** : espace de dilatation minimum de 9 mm entre le profilé de finition alu et le poteau.
- NL **BELANGRIJK** : een minimum uitzetvoeg van 9 mm voorzien tussen het aluminium afwerkingsprofiel en de einddop van de paal.
- DE **WICHTIG** : die Dehnfuge zwischen dem oberen Aluminiumabschlussprofil und der Pfostenabdeckung muss mindestens 9 mm sein.